



M5 GPS / M5 GPS DHC Electric Trolley Instruction Manual

EN

REGISTER ONLINE

www.motocaddy.com/warranty



IMPORTANT: Scan the QR code to ensure that your M5 GPS software remains up to date and performance is always optimised



Distance Measurement Device (DMD) features are legal to use when local USGA and R&A rule 4.3 is in effect. Always check local and competition rules prior to commencing play



Visit www.motocaddy.com/instructions for other Motocaddy instructions including translations

Contents

Registration / Serial Number / Information about DHC.....	3	Dynamic Pin Location / Hole Advancement	20
Safe Use / Trolley Care	4	Hazard Information.....	21
Trolley Care / Battery Care & Advice.....	5	Shot Measurement / Units of Measure.....	22
Charging Instructions / Lithium Battery Care	6	Round Timer / Tee Selection.....	23
Lithium Battery Care	7	Score Tracking / Ending your Round	24
Attaching the Wheels / Inverting the Wheels.....	8	AED Locator & CPR Instructions	25
Front Wheel Alignment.....	9	Connecting to WiFi / Firmware Updates.....	26
Unfolding your Trolley.....	10	Course Updates	27
Folding your Trolley	11	Smartphone Notifications / Motocaddy App Installation....	28
Upper & Lower Bag Supports.....	12	Enabling Bluetooth / Pairing your Phone	29
Adjusting the Bag Supports.....	13	Notification Settings / Notification Stacking.....	30
Equipment Overview	14	Language Settings / Competition Mode.....	31
Starting, Stopping & Changing Speed / Battery Meter.....	15	Factory Reset / Demo Mode	32
USB Charging / Clock	16	Introduction to DHC / Parking Brake	33
Adjustable Distance Control.....	17	FCC Statement.....	34
Introduction to GPS Mode / Using GPS Mode.....	18	Declaration of Conformity.....	35
GPS Mode Overview	19		

IMPORTANT - Software Updates

The M5 GPS has been developed to include WiFi powered, Over the Air (OTA) course and system updates. It is recommended that you always use the latest firmware version to enable you to take advantage of new features and system improvements. You can register your email address to join our dedicated M5 GPS mailing list by scanning the QR code or visiting www.motocaddy.com/m5gps.



Locating your Serial Number

The serial number for this M-Series trolley is located on the trolley underside next to the motor (fig. 1). This number is required when registering your warranty online and should be kept handy for future use.

The same number should also be on the box received with your trolley. Please ensure you keep hold of the packaging in case you need to return your trolley for any reason. A proof of purchase must also be kept in case your trolley requires servicing during its warranty period.



Fig 1

Please keep a record of your trolley serial number here for future reference:

M	C	M												
---	---	---	--	--	--	--	--	--	--	--	--	--	--	--

Information about DHC (Downhill Control) models

The information in this instruction manual applies to both standard and DHC electric trolley models. For DHC specific functionality, please turn to page 33.

Safe use of your Trolley / Trolley Care

Safety cut-out

This Motocaddy trolley is fitted with a timed safety cut-out feature. Once started the trolley will automatically cut power to the motor after ten minutes to prevent any possible damage to the trolley. Pressing the 'On/Off' button will restart the trolley.

Safe use of your Trolley

Motocaddy trolleys are designed for the transportation of golf bags and clubs contained within. Using the trolley for any other purpose may cause damage to the trolley and cause harm to the user.

- Do not attempt to transport any other equipment
- The trolley is not designed for the transportation of people
- Do not use the trolley to assist you when going up hills
- Submerging the trolley in water (e.g. a lake) is likely to cause damage to the trolley
- Do not operate the trolley whilst under the influence of drugs or excessive amounts of alcohol
- **All batteries must be disconnected from the trolley before folding, storage and transportation**

Caring for your Trolley

Although your Motocaddy trolley has been weatherproofed, please follow these simple guidelines to help protect your trolley:

- Do not store your trolley outside
- Try to minimise exposure to rain as much as possible with an umbrella during heavy rainfall
- Wipe excess water from the trolley prior to storage
- Never use a pressure washer to clean your trolley. To prevent water damage, wipe down with a damp cloth
- Avoid using high pressure air hoses near moving components
- Avoid exposure to items which may scratch, damage or exert excessive force on the LCD display

This Motocaddy trolley is designed to require very little maintenance. We do however recommend giving your trolley regular checks to ensure:

- There is no build up of excess mud and dirt
- The front wheel nut is on tightly and quick release lever is clamped down
- The front wheel is not clogged up and turns freely

Only original Motocaddy parts should be used when repairing your trolley.

Battery Care & Advice

All batteries must be charged as soon as possible after each use. Leaving batteries discharged for long periods of time will affect the battery life.

Please ensure that only batteries supplied by Motocaddy are charged with Motocaddy chargers. Cyclic battery chargers are designed specifically in accordance with the battery manufacturer's requirements. The Lithium battery charger **MUST NOT** be used to charge any other battery and is designed for use with Motocaddy Lithium batteries only.

The charger should only be connected to an earthed socket outlet; the battery charger should only be opened and maintained by authorised personnel. Unauthorised opening will invalidate your warranty.

The battery must be stored and charged on a dry non-carpeted surface and charged at temperatures ranging between 10°C and 30°C. Charging above or below these temperatures is not recommended as it can reduce the battery capacity.

When connecting your battery to the trolley, please ensure that the connections match up black to black and grey to grey.

Charging your Lithium Battery / Lithium Battery Care

Charging your Lithium Battery

1. Unplug the Lithium battery from the trolley. This should always be performed before folding the trolley to avoid damage to the battery and/or trolley
2. Plug the charger into your mains supply
3. Attach the battery cable to the charger matching black to black and grey to grey
4. When the charging LED indicator has turned green, the battery is fully charged and ready to be used

 RED - Battery charging   GREEN - Battery fully charged and ready to be disconnected

5. The charging process will take between 3 to 5 hours depending on the depth of discharge (Please be aware that this may take longer for the first few charges)
6. Once charging is complete please disconnect the charger from the mains power supply
7. Finally disconnect the charger from the battery

If you connect the battery to the charger and the LED goes out, this is likely to indicate that the battery is fully charged. Please double check the battery on the trolley to ensure that it is fully working.

Caring for your Lithium Battery

- Try to avoid getting the battery too wet (i.e. do not submerge the battery, avoid deep puddles and do not clean your trolley whilst the battery is still in the battery tray)
- Dropping the battery may cause damage to the internal cells
- Do not lift or carry the battery by the cable
- Use a damp cloth to clean off any dirt

Recommendations for hibernation of Lithium Batteries during winter months

If for any reason your Lithium battery is not going to be used for lengthy periods, e.g. 3 months over the winter, it is advised to store the battery half charged. To do this simply use the battery for a round of golf as usual and charge it for 1.5 hours at the end of the round. Before the battery is used again, recharge it (top it up) prior to use.

We recognise that extended absences are not always planned in advance, however when it is likely that you will not be using your battery for a period of time it is good practice to follow these steps to extend the life of your Lithium battery. Please ensure that the charger is ALWAYS disconnected from the battery after charging.

Battery Management System (BMS)

Motocaddy Lithium batteries are fitted with a comprehensive battery management system (BMS) to protect the battery from excessive abuse, high currents, deep discharge and overcharge. When the battery is delivered there may be no output as the BMS is designed to maximize safety whilst shipping. Please ensure that the battery is fully charged prior to connecting it to your trolley as this will activate the BMS and effectively 'switch-on' the battery. From time to time, at deep discharge or long term storage the BMS may switch-off the battery. A full battery charge will rectify this problem.

Motocaddy golf trolleys are designed to work with the BMS system installed in the Lithium batteries and the voltage meter is also synchronised to work in conjunction with the battery. If for any reason the voltage on the battery falls below the low battery warning on the trolley, then the BMS may disable the battery to protect it. Again if this occurs please recharge fully. Please be aware that Lithium batteries tend to 'drop off' quickly at the end of the cycle so it is not advisable to attempt to play excessive holes as the BMS will activate for protection purposes.

Attaching the Wheels / Inverting the Wheels

Attaching the Wheels

There is a left and a right wheel and it is important that you attach them on the correct side, otherwise the trolley will not move. There is an “L” and “R” on the inside of the wheel on the central hub. Left and Right sides are determined when stood behind the trolley at the handle.

DHC trolley models do not have a specific left and right wheel.

To attach the wheels follow these simple steps:

1. Push the quick release button in towards the centre of the wheel
2. Slide the wheel onto the trolley axle as far as it will go (onto the inner groove)
3. Once in position, release the button and pull the wheel outwards slightly to lock
4. An audible ‘click’ will confirm the wheel is in the correct position

The outer groove can be used as a “free wheel” option if you run out of battery power.

To check you have attached the wheels correctly onto the inner groove, you will find they only rotate freely in one direction (not applicable to DHC models).

Inverting the Wheels

The wheels can be inverted to reduce the trolley width for transportation and storage.

1. Push and hold the quick release button while sliding the wheel off the axle
2. Flip the wheel over, push and hold the button, then slide onto the axle
3. Release the button and pull the wheel out slightly until it engages with the free wheel groove

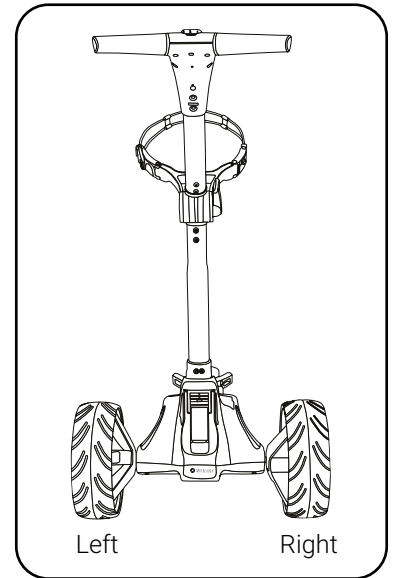

Adjusting the Front Wheel Alignment

In the unlikely event that your trolley is not tracking in a straight line, the alignment of the front wheel can be adjusted to rectify the fault. This problem can be caused by a number of factors including a slightly loose bag support or an unevenly packed golf bag.

To alter the alignment of the front wheel, follow these simple steps:

1. Lift the quick release lever positioned on the front wheel housing and loosen the wheel nut (fig. 1)
2. There are two small metal dials on either side of the housing that are used to realign the wheel (fig. 2)
3. If your trolley is veering to the right, you will need to turn the left hand dial clockwise and the right hand dial anti-clockwise
4. If your trolley is veering to the left, you will need to turn the right hand dial clockwise and the left hand dial anti-clockwise
5. Tighten the wheel nut and push down the lever to lock the wheel back into place (fig. 3)

This procedure can be carried out until you are happy the trolley is moving in a straight line (please note you may only need to adjust one dial at a time).

These instructions are based on positioning yourself in front of the trolley looking at the wheel.

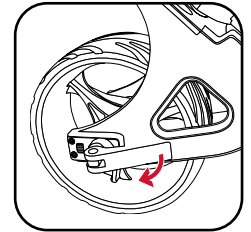

Fig 1

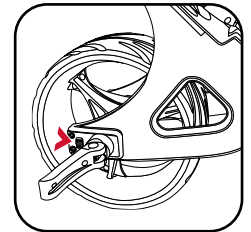

Fig 2

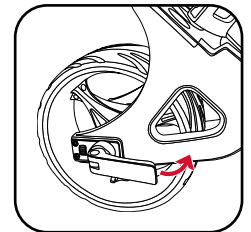

Fig 3

Unfolding your Trolley

Unfolding your Trolley

We recommend unfolding your trolley once the wheels have been un-inverted and reattached (see page 8).

1. Lift the upper bag support slightly and release the upper latch (fig. 1)
2. Unfold the handle and re-secure the latch (fig. 2)
3. Release the lower latch (fig. 3)
4. Lift the trolley handle up into position (fig. 4). The front wheel will automatically unfold
5. Re-secure the lower latch and ensure the auto-open stand is folded away (fig. 5)

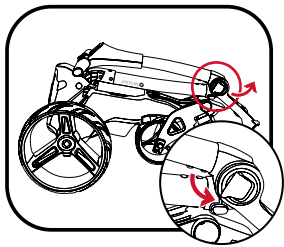

Fig 1

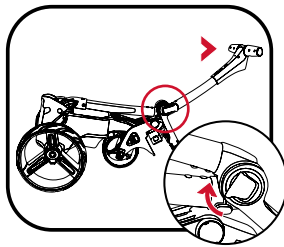

Fig 2

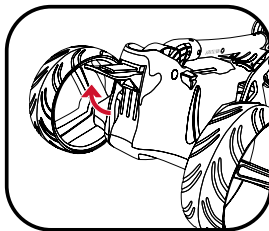

Fig 3

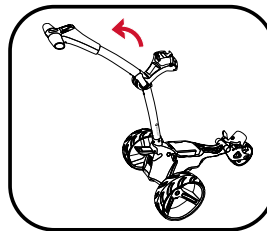

Fig 4

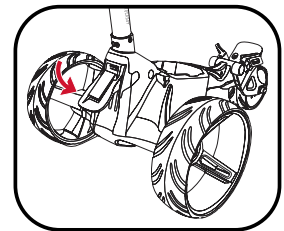

Fig 5

Folding your Trolley

1. Release the lower latch (fig. 1). The auto-open stand will also be activated
2. Fold the frame forward until fully extended (fig. 2). The front wheel will automatically fold underneath
3. Release the upper latch and fold the handle back until the trolley is fully folded (fig. 3)
4. Re-secure both latches. If you wish to stand the trolley upright, leave auto-open stand out. Remember to ensure the auto-open stand is pushed down if not being used (fig. 4)
5. The wheels can be inverted to reduce the trolley width for transportation and storage (fig. 5). See page 8 for details

Please ensure the auto-open stand is folded away when not in use to prevent damage.

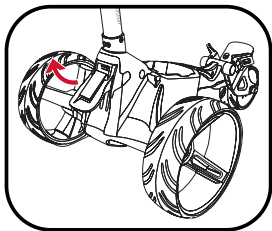

Fig 1

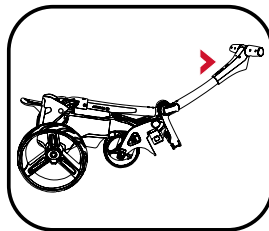

Fig 2

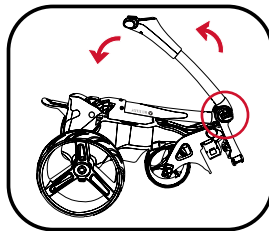

Fig 3

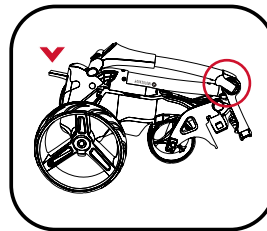

Fig 4

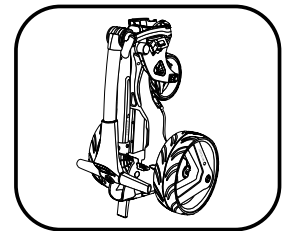

Fig 5

Upper & Lower Bag Supports

Upper Bag Supports

The upper bag support straps are secured using the following steps:

1. Stretch the elasticated strap around the bag & loop the rounded bar underneath the hook (fig. 1)
2. Position the two placement straps centrally on your golf bag (fig. 2)

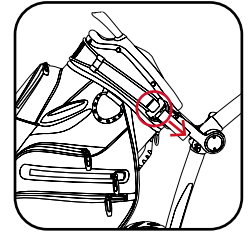

Fig 1

Lower Bag Supports

This Motocaddy trolley is fitted with the EASILOCK™ bag attachment system.

If you are using an EASILOCK™ compatible golf bag please follow these simple instructions:

1. Remove the two pre-fitted lower bag straps by depressing the rear button and sliding (fig. 3)
2. Match up the indicating line on the golf bag with the line on the lower bag support
3. Lower the bag until the pins lock in position. You should hear an audible 'click'

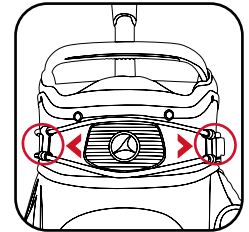

Fig 2

If you are using a non-EASILOCK™ golf bag, please use the following instructions:

1. Stretch the lower bag strap around the bag base & loop the rounded bar underneath the hook
2. Position the two placement straps centrally on the base of your golf bag

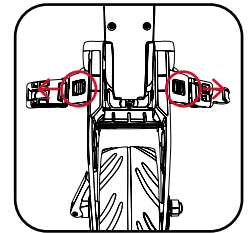

Fig 3

Please ensure all straps are hooked securely before releasing. Failure to do so could result in injury.

Adjusting the Bag Supports

The bag support straps are manufactured from elasticated material to allow your golf bag to be held tightly in position.

The strap should be adjusted to be reasonably tight around the golf bag:

1. Unclip the elasticated straps from the housing by pulling outwards in the direction shown (fig. 1)
2. Move the bar as required to tighten or loosen the strap fitting. Pulling the bar downwards will tighten, pushing it upwards will loosen (fig. 2)
3. Ensure that the straps are clipped back into the housing before use (fig. 3)

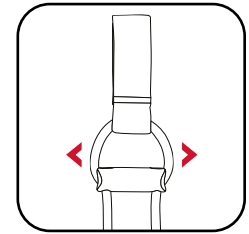

Fig 1

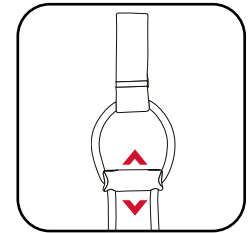

Fig 2

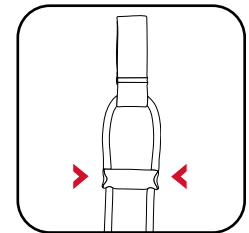
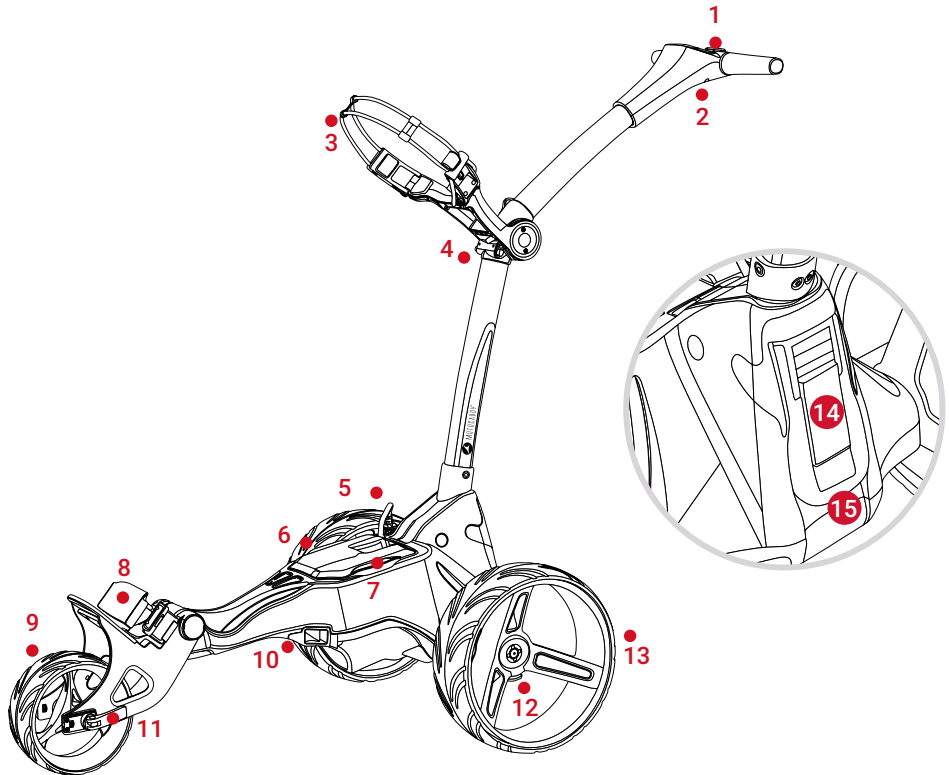

Fig 3

Equipment Overview

Equipment Overview

1. LCD Touchscreen Display
2. USB Charging Port (under handle)
3. Upper Bag Support
4. Upper Release Latch
5. Battery Connector
6. Battery
7. Battery Tray
8. EASILOCK™ Lower Bag Support
9. Front Wheel
10. Motor (under Battery Tray)
11. Front Wheel Alignment Adjusters
12. Rear Wheel Release Button
13. Rear Wheels
14. Auto-Open Stand
15. Lower Release Latch



When the battery is initially connected, a Motocaddy logo graphic will be displayed, followed by a blank screen for around 15 seconds to allow the processor to boot up. Please do not attempt to restart the trolley during the booting procedure.

Starting, Stopping & Changing Speed

The main 'On/Off' button is used to start and stop the trolley, whilst also controlling the speed, which can be adjusted while the trolley is stationary or in motion. The trolley has 9 speed settings (1 to 9) with 1 being the slowest and 9 the fastest.

To increase the speed, rotate the speed dial clockwise, or anti-clockwise to decrease the speed, you will notice the number of green bars surrounding the speed indicator increases and decreases with the number.

To start the trolley, simply select your required speed setting and press the 'On/Off' button. The trolley will smoothly accelerate until it reaches the selected speed and the speed indicator will change from white to green to indicate that the trolley is under power.

To stop the trolley, simply press the 'On/Off' button again - there is no need to reduce the speed setting. The speed indicator will return to white.

Battery Meter

The M5 GPS includes an on-screen battery meter in the top right corner which provides an indication of remaining battery capacity. The battery bar is green when fully-charged. The bar will gradually reduce while turning amber and then red as battery capacity reduces.

If battery capacity gets low, a red 'low battery' warning icon will appear in the speed indicator. Press the 'On/Off' button to continue using the trolley. It is recommended to disable Bluetooth, stop USB charging and limit GPS usage until the battery has been charged.



USB Charging

This trolley features a USB charging port designed to charge USB powered devices during your round.

Simply remove the covering cap and plug a USB cable into the charging port located on the underside of the handle. The device will continue charging while the cable is attached and the battery is connected.

The rate of charge will be slower than a mains AC charger and similar to plugging the device into a PC. The USB charger takes power from the main trolley battery and continuous charging will reduce the battery capacity between charges. The trolley is designed to disable the USB charging port when the battery capacity reaches a preset level.

Clock Settings

The M5 GPS includes a clock which is visible on the Home (fig. 1) and GPS mode (fig. 2) screens. The clock will set automatically each time the trolley is turned on and either has a strong enough GPS signal or connects to a WiFi network.

It is possible to change the clock format and time zone settings. Starting on the Home screen, select “Settings” and then “Time” from the settings menu. You will then have the option to change the following options:

- **Format** (12 hour / 24 hour)
- **Time Zone** (GMT +/- 12 hours)
- **Daylight Savings Time** (On / Off)

Please be aware that the clock will only be displayed when an accurate time signal has been received.

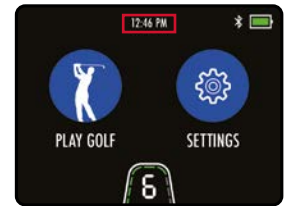

Fig 1 - Home Screen - Clock

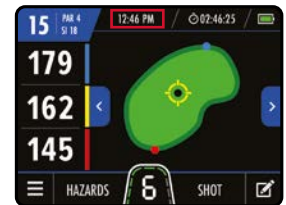

Fig 2 - GPS Mode - Clock

Adjustable Distance Control

This trolley features an easy to use Adjustable Distance Control (ADC) function which will allow you to send your trolley ahead of you from 5 - 60 yards or metres. The speed setting will automatically change to speed 5 during the ADC setting process.

1. While stationary, hold down the 'On/Off' button for 2 seconds (the speed will change to 5)
2. The ADC settings box will appear and indicate '15 YARDS/METRES' (fig. 1 & fig. 2)
3. Rotate the 'On/Off' button clockwise to increase the distance and anti-clockwise to decrease
4. Press the 'On/Off' button to start the trolley moving

Whilst the trolley is running under ADC mode, the Motocaddy symbol will be displayed within the ADC settings box and rotate until the desired distance is reached (fig. 3). The trolley can be stopped by pressing the 'On/Off' button once. DHC models will automatically apply the parking brake once the trolley has reached the desired distance and stopped.

In the unlikely event that your trolley fails to register distance whilst in ADC mode, the trolley will cut power to the motor to prevent the trolley from travelling too far. The trolley can be reset by pressing the 'On/Off' button once, thereby allowing you to continue to use the trolley with ADC disabled until you are able to contact our Technical Support team.

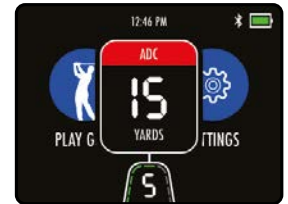

Fig 1 - Home Screen - ADC



Fig 2 - GPS Mode - ADC



Fig 3 - GPS Mode - ADC Moving

Introduction to GPS Mode / Using GPS Mode

Introduction to GPS Mode

The M5 GPS trolley is pre-loaded with over 40,000 worldwide courses and includes front, middle and back of green distances, along with hole information, hazards, score tracking, shot measurement and round timer.

IMPORTANT : Distance Measurement Device (DMD) features are legal to use when local USGA and R&A rule 4.3 is in effect. Always check local and competition rules regarding the use of DMD and Push Notifications prior to commencing play.

Using GPS Mode

It is really simple to start a round in GPS mode:

1. From the Home screen select "Play Golf" (fig. 1)
2. The trolley will display "Searching" while it acquires an accurate GPS location (fig. 2)
3. A list of local courses will be displayed, with the nearest at the top (fig. 3)
4. Select the course you wish to start playing

It is also possible to select an alternative course from the settings menu within the GPS mode. Please be aware that the Round Timer and Score Tracking will be reset when a course is changed.

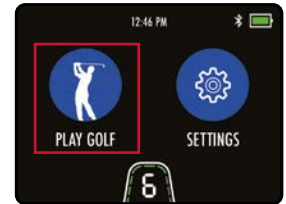

Fig 1 - Home Screen - Play Golf

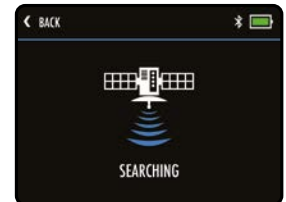

Fig 2 - Course Search

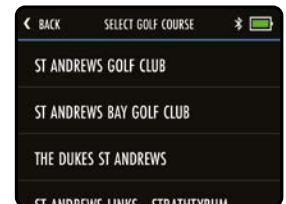

Fig 3 - Course Selection

GPS Mode Overview

1. Green Map
2. Back Distance
3. Middle Distance / Dynamic Pin Distance
4. Front Distance
5. Settings Menu
6. Hazards Information
7. Speed Indicator
8. Shot Measurement
9. Scorecard
10. Previous Hole
11. Next Hole
12. Battery Indicator
13. Round Timer
14. Clock
15. AED Locator
16. Par / Stroke Index
17. Hole Number



Dynamic Pin Location / Hole Advancement

Dynamic Pin Location

The M5 GPS allows you to move the location of the pin to give a more accurate distance measurement. Touch the point on the green that you want to move the pin to and the centre distance will update (fig. 1).

Hole Advancement

The M5 GPS will automatically advance to the next hole when you move towards the next tee.

It is also possible to change the hole manually using one of the following methods:

- Using the left and right arrows (fig. 2a)
- Touching the hole number in the top left corner (fig. 2b) and selecting the required hole
- Selecting "Select Hole" from the GPS menu and tapping the required hole (fig. 3)

Please be aware that holes will advance sequentially from the 1st hole onwards. If you are commencing play at a different location, you will need to manually advance to the required hole.



Fig 1 - GPS Mode - Pin Location

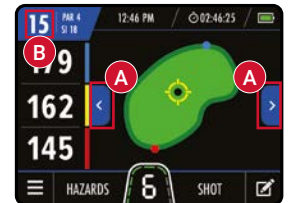

Fig 2 - GPS Mode - Hole Advance

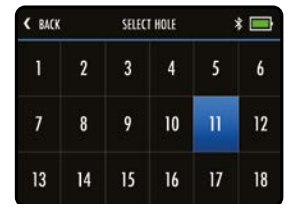

Fig 3 - Select Hole

Hazard Information

The M5 GPS also includes a list of on-course hazards. You can view the hazards for the hole you are currently playing by selecting “Hazards” at the bottom of the GPS mode screen (fig. 1). Once selected, the screen will provide distances to the closest four hazards (fig. 2). All distances are to the front of the hazard, except carry distances which are to the back. It will only display hazards between you and the green.

You can switch back to the green view by tapping “Green” (fig. 3).

List of Hazard Abbreviations

LFB	Left Fairway Bunker
MFB	Middle Fairway Bunker
RFB	Right Fairway Bunker

LFW	Left Fairway Water
MFW	Middle Fairway Water
RFW	Right Fairway Water

LGB	Left Green Bunker
RGB	Right Green Bunker
FGB	Front Green Bunker
BGB	Back Green Bunker

LFWC	Left Fairway Water Carry
MFWC	Middle Fairway Water Carry
RFWC	Right Fairway Water Carry

CRK	Creek
CRKC	Creek Carry
EOF	End of Fairway (Doglegs)

LGW	Left Green Water
RGW	Right Green Water
FGW	Front Green Water
BGW	Back Green Water



Fig 1 - GPS Mode

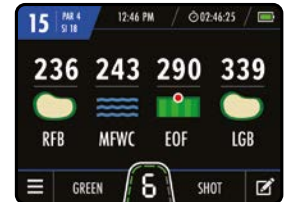

Fig 2 - Hazard Information

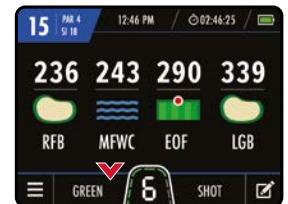

Fig 3 - Hazard Information

Shot Measurement / Units of Measure

Shot Measurement

It is possible to use your M5 GPS to measure the length of a shot taken. Distances are measured using GPS co-ordinates, which means that you do not need to walk in a straight line between shots to provide an accurate measurement. Shots can be measured in both yards and metres.

To measure shot distance, press "Shot" on the GPS mode screen (fig. 1) before setting off to find your ball. The "Shot" text will be replaced with a yellow number (fig. 2) and start measuring the distance from the point at which it was started.

To stop measuring, touch the shot measurement distance to close.

Units of Measure

The M5 GPS can display and measure distances in either Yards or Metres. To select preferred units:

1. From the Home screen select "Settings" and then "Units"
2. Select "Yards" or "Metres" (fig. 3)
3. Select "Close" to exit

This can also be changed from the settings menu within the GPS mode.



Fig 1 - GPS Mode

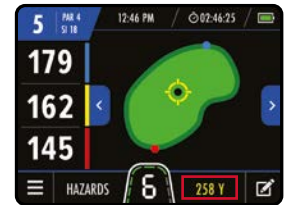

Fig 2 - GPS Mode - Shot Distance

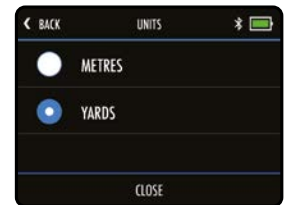

Fig 3 - Units of Measure

Round Timer

The round timer is displayed at the top of the GPS mode screen next to the clock (fig. 1) and will start counting as soon as you enter GPS mode and select a course.

You can view, pause and reset the timer (fig. 2) by selecting it on the display.

If reset, the timer will stop and you will need to select "Start" to begin counting again.

Tee Selection

It is possible to set the default tee type to display correct hole information (Par and Stroke Index).

This can be set within the Home settings or GPS mode settings menu (fig. 3).



Fig 1 - GPS Mode - Round Timer

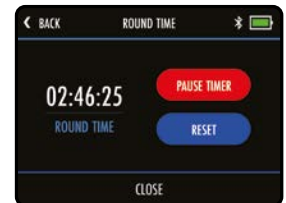

Fig 2 - Round Timer Settings



Fig 3 - Tee Selection

Score Tracking / Ending your Round

Score Tracking

You can use your M5 GPS to keep track of your score and access a score summary at any point during the round. To enter a score, select the scorecard logo (fig. 1) at the bottom right corner of the GPS screen.

This will show the current hole information with the option to enter a score (fig. 2). Tap "+" and "-" to change the score and then select "Back" to return to the main GPS screen. You can also select "Prev Hole" and "Next Hole" to enter a score for more than one hole at the same time.

You can access a score summary at any point during the round by selecting "Score Summary" from the GPS screen settings menu. The Score Summary will show 'Total Strokes' taken and 'Score' related to Par (fig. 3). Once finished, select "Close" to return to the main GPS screen or "End Round" if finished.

Please be aware that scores are not stored or accessible once a round has ended.

Ending your Round

The round can be ended at any point by selecting "End Round" from the GPS screen settings menu. If you have used score tracking, a score summary will be displayed with an option to "End Round". If you have not used score tracking, you will return to the Home screen.



Fig 1 - GPS Mode

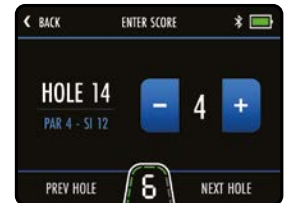

Fig 2 - Score Entry

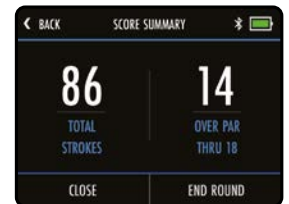

Fig 3 - Score Summary

AED Locator & CPR Instructions

The M5 GPS can indicate the availability and location of on-course defibrillators and provide golfers with Cardiopulmonary Resuscitation (CPR) instructions. The feature can be enabled by selecting "AED Locator" within the home settings menu and selecting "On" (terms & conditions apply).

If the course you are playing has an on-course defibrillator and has registered details on the Motocaddy AED database, the main GPS screen will display an AED Icon at the top of the screen (fig. 1).

Tap the AED Icon to access information about the location of on-course defibrillators and the contact number to gain access (fig. 2). From this screen, you can also access step-by-step CPR instructions (fig. 3) by selecting "CPR Instructions".

Please be aware that AED and CPR features are available in selection regions only and usage requires acceptance of the AED & CPR feature 'Terms of Use' available at www.motocaddy.com/defib-cpr-terms.



Fig 1 - GPS Mode - AED Icon



Fig 2 - AED Locator



Fig 3 - CPR Instructions

Connecting to WiFi / Firmware Updates

The M5 GPS is able to easily update both firmware and courses via WiFi powered Over-the-Air updates.

Connecting to a WiFi Network

Before attempting an Over-the-Air (OTA) update, the trolley will need to be connected to a WiFi network.

1. From the Home screen select "Settings" and then "WiFi"
2. Select "WiFi Disabled"
3. Select "On" and then select "Close"
4. Tap "Select Network" and choose the required network from the list (fig. 1)
5. Enter the WiFi password (tap the eye icon to view password) and select "Enter" (fig. 2)
6. Once connected select "Close" to exit

Firmware Updates (OTA)

To check current software version and install updates:

1. From the Home screen select "Settings" and then "Check for Updates"
2. You will be asked whether you want to check for updates. Select "Yes"
3. The trolley will search and indicate whether a newer firmware version is available
4. If there is newer firmware, you will see an option to select "Yes" or "Cancel" (fig. 3)
5. Select "Yes" to continue and install the update, or "Cancel" to return to the settings menu
6. During installation, the trolley will restart and show the Home screen when completed

We strongly recommend checking for firmware updates before using the trolley for the first time. The OTA process can take up to 5 minutes to complete. During installation, the trolley may automatically reboot multiple times and the screen will go blank. When the Home screen is displayed, the OTA is complete. It may be necessary to unpair your mobile device and re-pair after performing an OTA - see page 29.

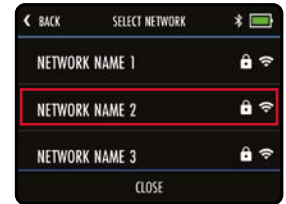

Fig 1 - WiFi Network List



Fig 2 - WiFi Password Entry

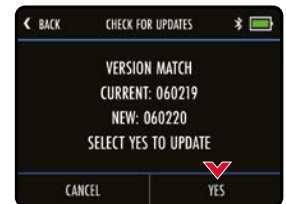

Fig 3 - Check for Updates

Course Updates (OTA)

The M5 GPS is pre-loaded with over 40,000 worldwide courses. To check for an updated course map, the trolley will need to be connected to a WiFi network:

1. From the Home screen select "Settings" and then "Update Course"
2. Enter the name of the course (you do not need to enter the full name) and select "Search" (fig. 1)
3. The trolley will then display a list of courses which meet the search criteria (fig. 2)
4. Select the course that you want to update from the search results
5. You will be shown additional course information to help confirm that you have selected the correct course (if required, tap "Back" to select an alternative course)
6. Select "Update" to initiate the update (fig. 3)
7. The course will then be updated and "Updating Course" will be displayed
8. Once complete, the trolley will confirm that the course has been successfully updated
9. Select "Close" to exit

Please submit requests for mapping updates or new course mapping using the 'Report Mapping Issue' option within the Motocaddy app support menu.



Fig 1 - Course Search

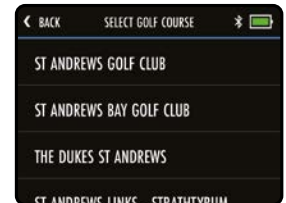

Fig 2 - Course Selection

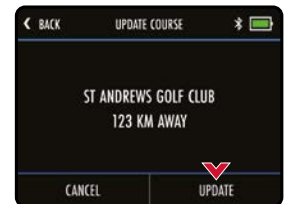

Fig 3 - Update Confirmation

Smartphone Notifications / Installing the Motocaddy App

Introduction to Smartphone Notifications

The M5 GPS trolley can be linked to the Motocaddy GPS app via a Bluetooth® connection on any compatible smartphone; allowing the trolley's LCD screen to receive optional push notifications for text messages, email, missed calls and other compatible apps. It is possible to use the M5 GPS with or without push notifications enabled.

Installing the Motocaddy Smartphone App

It is necessary to install the **Motocaddy app** to utilise the M5 GPS smartphone push notification features.

The Motocaddy GPS app is compatible with devices running iOS 9 or later and Android version 4.4 or later. Please note, not all Bluetooth enabled mobile phone handsets are compatible with the M5 GPS Bluetooth connection and pairing for other devices cannot be guaranteed. Please check your device compatibility before attempting to download the app.

To install the 'Motocaddy GPS' app, search for "Motocaddy" on either the Apple App Store or on Google Play.

Apple Devices



Android Devices



Once installed, select the Motocaddy GPS app and it will load the registration screen. When using the app for the first time, you will be prompted to allow the app to access your location and it is important that this is enabled to use standalone GPS features within the app.

We recommend that you complete the app registration process to allow us to keep you informed about future updates to both the app and push notification functionality. Please note that completing the app registration does not register the trolley.

Enabling Bluetooth

In order to pair your phone to your trolley, you will need to ensure that Bluetooth is enabled on the trolley:

1. From the Home screen select "Settings" and then "Bluetooth" (fig. 1)
2. If Bluetooth is off, select "Yes" to turn it on

When Bluetooth is enabled you will see the Bluetooth logo on the display next to the battery meter.

Pairing your Phone

To pair your M5 GPS to a compatible smartphone, you must first ensure Bluetooth is enabled on both devices (see above) and then follow the below steps:

1. Open the Motocaddy app on your phone and select "Pair Device" button (fig. 2)
2. Select the correct trolley model from the list and select "Next"
3. Further instructions will be displayed. When ready, select "Pair Device"
4. Once the trolley and phone have found each other, both devices will display a six digit code (fig. 3). If these codes match, select "Pair" on both devices
5. Both the trolley and phone will confirm that pairing has been successful
6. Select "My Device" on the phone for further settings and "Close" on the trolley screen to continue

The Motocaddy app can be closed once pairing is complete or used as an additional GPS device. Once pairing is complete, it is not necessary to open the Motocaddy app to display notifications on the trolley screen, however the app can be used to control notification settings or unpair your phone.

During initial startup, the Bluetooth on your trolley will take around 60 seconds to initialise and will automatically reconnect to your phone when in range. Bluetooth can be disabled if required.

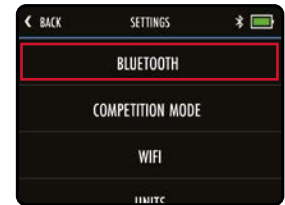

Fig 1 - Home Settings Menu

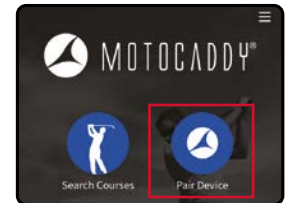

Fig 2 - Motocaddy App

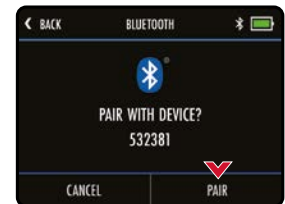

Fig 3 - Trolley Pairing Code

Notification Settings

It is possible to pre-set which smartphone notification types are displayed on the trolley screen (fig. 1, fig. 2 & fig. 3) using the device 'Settings' menu within the Motocaddy app.

There are also other app specific notification settings within your phone that need to be enabled for the notifications to be displayed on your trolley.

For a full list of compatible apps, plus individual app notification settings (including the 'Push Notifications' option), please visit www.motocaddy.com/m5gps.

Notification Stacking

Notifications will be displayed in chronological order, with the oldest notification displayed at the top.

Once viewed, notifications can be closed by selecting "Close" or tapping "Back" to exit without clearing.

When multiple notifications are available, selecting "Close" will hide the current notification and display the next alert.



Fig 1 - Missed Call

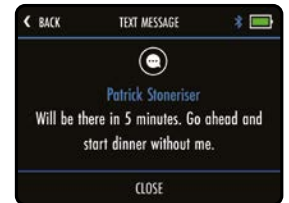

Fig 2 - Text Message



Fig 3 - Email

Language Settings

The M5 GPS can be used in a number of different languages:

1. From the Home screen select "Settings" and then "Languages"
2. Select preferred language and then "Close" to confirm (fig. 1)

Competition Mode

It is possible to temporarily disable GPS using the competition mode should competition rules dictate. It is recommended that you always check competition rules before using your trolley with GPS enabled.

To Enable/Disable Competition mode:

1. From the Home screen select "Settings" and then "Competition Mode"
2. Select "On" (to enable) or "Off" (to disable)
3. Select "Close" to exit

When Competition Mode is enabled, the "Play Golf" option will be disabled and the Home screen will display "Competition Mode Enabled" (fig. 2).



Fig 1 - Language Settings

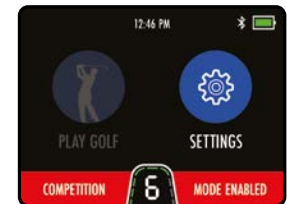

Fig 2 - Competition Mode

Factory Reset

Should you experience a problem with your M5 GPS, it is possible to reset the trolley back to its original factory default settings:

1. From the Home screen select "Settings" and then "Reset all Settings"
2. You will be asked to confirm that you want to go ahead with the reset, select "Yes" (fig. 1)
3. A confirmation screen will be displayed and select "Close" to exit

Resetting the trolley to factory default will clear any setting preferences.

Demo Mode

The M5 GPS features a Demo Mode to allow demonstration of features when a GPS signal is not available. To enable Demo Mode, navigate to the "Settings" menu from the Home screen and select "Demo Mode".

Demo Mode can be toggled "On" and "Off". Select "Close" to confirm. Once enabled, the "Play Golf" button will display a list of demo courses (fig. 2).

It is important to disable Demo Mode before attempting to play a round of golf.

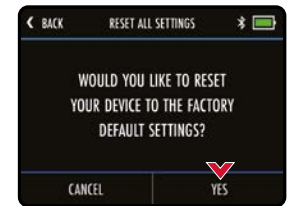

Fig 1 - Factory Reset

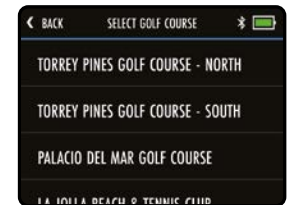

Fig 2 - Demo Mode

The below information is applicable to DHC models ONLY.

Introduction to DHC

The letters DHC stand for 'Downhill Control' and mean that your trolley will automatically maintain a controlled speed whilst travelling down hills.

Whenever you are looking to move the trolley, even if just to reposition it ready to use, always put it on a low speed setting to make it easier to steer.

Using the DHC Parking Brake

DHC models are fitted with an electronic parking brake. To use this feature, the trolley must be in a stationary position. The parking brake is initiated by rotating the speed dial down to 1 and then rotating one click further.

Once activated, the speed indicator will toggle between 'P' and number '1' (fig. 1 and fig. 2).

The speed setting can be adjusted whilst the parking brake is activated by turning the speed dial.

To release the parking brake, press the 'On/Off' button to start the trolley.

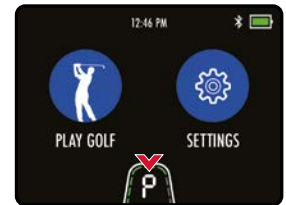

Fig 1 - Home Screen



Fig 2 - GPS Mode

FCC Statement

FCC Statement

1. This device complies with Part 15 of the FCC Rules.

Operation is subject to the following two conditions:

- (1) This device may not cause harmful interference, and
- (2) This device must accept any interference received, including interference that may cause undesired operation.

2. Changes or modifications not expressly approved by the party responsible for compliance could void the user's authority to operate the equipment.

FCC Radiation Exposure Statement:

The device has been evaluated to meet general RF exposure requirement. The device can be used in portable exposure condition without RF striction.

NOTE: This equipment has been tested and found to comply with the limits for a Class B digital, pursuant to Part 15 or the FCC Rules.

These limits are designed to provide reasonable protection against harmful interference in a residential installation. This equipment generates, uses and can radiate radio frequency energy and, if not installed and used in accordance with the instructions, may cause harmful interference to radio communications, However, there is no guarantee that interference will not occur in a particular installation. If the equipment does cause harmful interference to radio or television reception, which can be determined by turning the equipment off and on, the user is encouraged to try to correct the interference by one or more of the following measures:

- (1) Reorient or relocate the receiving antenna
- (2) Increase the separation between the equipment and receiver
- (3) Connect the equipment into an outlet on a circuit different from that to which the receiver is connected
- (4) Consult the dealer or an experienced radio/ TV technician for help





DECLARATION OF CONFORMITY

ORIGINAL

Business Name and Full Address of Manufacturer

Motocaddy Ltd - Units 15-18 Stansted Distribution Centre,
Start Hill
Great Hallingbury

Hertfordshire
CM22 7DG

Name and Address of Authorised Representative

-

Name and Address of the Person in Community Authorised to compile the Technical File (if different to above)

-

Description of product (Commercial Name)

Motocaddy Electric Trolley

Function, Model, Type, Serial Number

Function: Electric Trolley

Model: S1/S1 DHC/S3 PRO/S3 PRO DHC/
S5 CONNECT/S5 CONNECT DHC/S7 REMOTE/
M1/M1 DHC/M3 PRO/M3 PRO DHC/
M5 CONNECT/M5 CONNECT DHC/M5 GPS/
M5 GPS DHC/M-TECH/C-TECH/M7 REMOTE

Type: Motocaddy Digital Range

Standards Used

BS EN ISO 12100 2010

Place of Declaration

Units 15-18 Stansted Distribution Centre,
Start Hill
Great Hallingbury

Hertfordshire
CM22 7DG

Date of Declaration Wednesday January 01, 2020

Declaration

I declare that the machinery fulfils all the relevant provisions of the following Directives:- Low Voltage Directive 2006/95/EC, Electromagnetic Compatibility Directive 2004/108/EC.

Person Empowered to Draw Up Declaration

Name: John Helas

Position: Managing Director

Signature:



Motocaddy Ltd, Units 15 - 18 Stansted Distribution Centre,
Start Hill, Great Hallingbury, Hertfordshire, CM22 7DG, United Kingdom

t: +44 (0)1279 712 370 e: info@motocaddy.com w: www.motocaddy.com



We are dedicated to protecting the environment and encourage the recycling of Motocaddy products through a free collection and disposal service. To find out more or to locate your nearest Motocaddy recycling point, please contact us through our website.

MC.20.62.003

EASILOCK™ Patent (GB) - GB2519073
USB Charging Port Patent (GB) - GB2473845
USB Charging Port Patent (AUSTRALIA) - 2010224448

Apple, the Apple logo, and iPhone are trademarks of Apple Inc., registered in the U.S. and other countries. App Store is a service mark of Apple Inc.

Android and Google Play are trademarks of Google Inc.

The Bluetooth® word mark and logos are registered trademarks owned by the Bluetooth SIG, Inc. and any use of such marks by Motocaddy is under license. Other trademarks and trade names are those of their respective owners.